

# The Performance of STBC Coded MIMO-OFDM System Based on Turbo Product Codes

Yejun He<sup>1</sup>, Guangxi Zhu<sup>1</sup>, Bijun Zhang<sup>1</sup>, Zhenming Zhang<sup>1</sup> and Xia Li<sup>2</sup>

1. Department of Electronics and Information Engineering, Huazhong University of Science and Technology

2. College of Information Engineering, Shenzhen University

Wuhan 430074, China

heyejun@126.com

**Abstract**—Space-Time Block Codes(STBCs) are designed to obtain the full diversity gain. However, STBCs are not designed to achieve an additional coding gain. Therefore, STBCs need to be concatenated with an outer code which provides a significant coding gain. Turbo Product Codes (TPCs) are a kind of high-efficient coding scheme with low latency decoding, which do not suffer from an error floor associated with turbo codes. This article considers the concatenation of TPCs with STBCs and sets up coded MIMO-OFDM system to improve the reliability of the wireless communication systems. Finally, the paper presents simulating environment of experiment testing.

**Keywords**- turbo product codes; multiple-input multiple-output; space-time block codes; OFDM; IMT2000

## I. INTRODUCTION

With the increasing demand for high-speed services in beyond the third generation(B3G, including the fourth generation, the fifth generation et al) mobile communications systems, forward error correction(FEC) codes and signal processing techniques are receiving much attention.

It is known that orthogonal frequency division multiplexing(OFDM)<sup>[1]</sup>, multiple-input multiple-output(MIMO) and their combination are critical technologies in B3G mobile communications. Space-Time Block Code(STBC) is a implementation scheme of MIMO. Generally, there are three categories of MIMO techniques<sup>[2]</sup>. The first class includes delay diversity, STBC<sup>[3-4]</sup>, and space-time trellis code(STTC)<sup>[5]</sup>. The second class employs a layered approach to increase capacity, for example, V-BLAST system suggested by Foschini et al<sup>[6]</sup> where full spatial diversity is usually not achieved. The third type exploits the knowledge of channel at the transmitter. It decomposes the channel coefficient matrix using singular value decomposition(SVD)<sup>[7]</sup>.

The Space-Time Block Codes(STBCs) are designed to obtain the full diversity gain. However, STBCs are not designed to achieve an additional coding gain. Therefore, STBCs need to be concatenated with an outer code which provides a significant coding gain.

In satellite mobile communication systems, if the first generation FEC is regarded as Reed-Solomon codes<sup>[8]</sup> and the second generation FEC is regarded as Turbo codes<sup>[9]</sup>, then the third generation FEC is turbo product codes<sup>[10]</sup> and low density

parity check(LDPC) codes<sup>[11]</sup>. TPCs and LDPC codes have been selected as FECs in satellite modulator/demodulator by Comtech company.

At present, domestic and overseas research literatures are either confined to the combination of turbo code and space time block code<sup>[12-14]</sup> as well as that of turbo code and BLAST<sup>[15]</sup>, or confined to the combination of turbo product code and space time block code<sup>[16-17]</sup> as well as that of turbo product code and OFDM<sup>[18]</sup>. TPC-STBC-OFDM system hasn't been reported over IMT2000 channels. In this paper, STBC proposed by Alamouti is employed.  $(64,57,4)^2$ ,  $(32,26,4)^2$ ,  $(16,11,4)^2$  TPCs are used as outer codes.

This paper is organized as follows. System model is introduced in Section II. The encoding and decoding of TPC are analysed in Section III. In Section IV, computer simulation results are presented to demonstrate the performance of the proposed STBC coded MIMO-OFDM system based on turbo product codes. Section V contains the conclusions.

## II. STBC CODED MIMO-OFDM SYSTEM BASED ON TURBO PRODUCT CODES

The MIMO-OFDM system based on turbo product codes is shown in Figure 1. An inverse FFT(IFFT) and a FFT is acted as a modulator and a demodulator, respectively. Figure 1 shows four paths with two transmit antennas and two receive antennas.

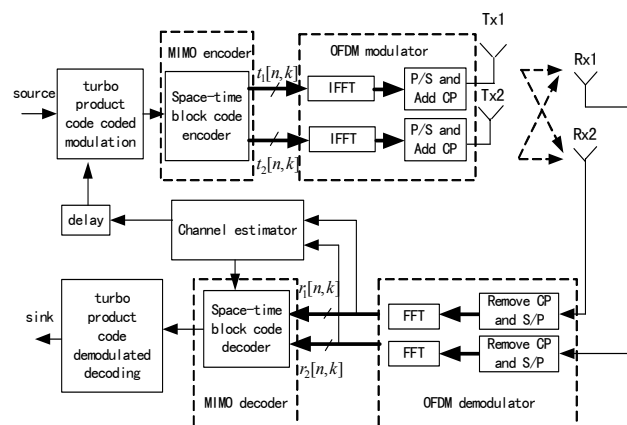

Figure 1. STBC coded MIMO-OFDM system based on TPCs

This work is supported by the National Natural Science Foundation of China (No. 60496315) and the National High Technology Research and development Program of China (No.2003AA12331005).

Without loss of generality, the system with  $M$  transmit antennas and  $L$  receive antennas is considered. The received signal at each receive antenna is the superposition of  $M$  distorted transmitted signals, which can be expressed as

$$r_j[n,k] = \sum_{i=1}^M H_{ij}[n,k]t_i[n,k] + w_j[n,k] \quad (1)$$

where  $j=1, \dots, L, n=1, \dots, N, k=0, \dots, K-1$ .  $H_{ij}[n,k]$  denotes the channel frequency response for the  $k$ th tone at time  $n$ th, corresponding to the  $i$ th transmit and the  $j$ th receive antenna.  $t_i[n,k]$  is input signal.

### III. THE ENCODING AND DECODING OF TURBO PRODUCT CODES (TPCs)

#### A. The encoding of TPCs

As an example of two-dimensional TPC  $c = c^1 \otimes c^2$ ,  $c^1 = (n_1, k_1, \delta_1)$ ,  $c^2 = (n_2, k_2, \delta_2)$ , where  $n_i, k_i$  and  $\delta_i$  ( $i=1,2$ ) are the codeword length, number of information bits, and minimum Hamming distance, respectively. The linear codes  $c^1$  and  $c^2$  are called constituent or component codes and the resultant  $(n_1 \times n_2, k_1 \times k_2, \delta_1 \times \delta_2)$  TPC has a code rate of  $R = R_1 \times R_2 = (k_1 \times k_2) / (n_1 \times n_2)$ . Two-dimensional TPC can be obtained as follows:

1) placing a  $k_1 \times k_2$  array of information bits as shown in Figure 2.

2)  $k_2$  rows of  $k_1$  information bits are encoded by row encoder  $c^1$  to get a matrix of  $k_2$  rows and  $n_1$  columns.

3)  $n_1$  columns of the matrix are encoded by column encoder  $c^2$  to get a matrix of  $n_2$  rows and  $n_1$  columns.

Above step 2) and 3) cannot be performed at the same time, therefore the encoding scheme is known as serial concatenation. To decrease implementation complexity, the rows and columns are encoded by the same constituent code.

#### B. The decoding of TPCs

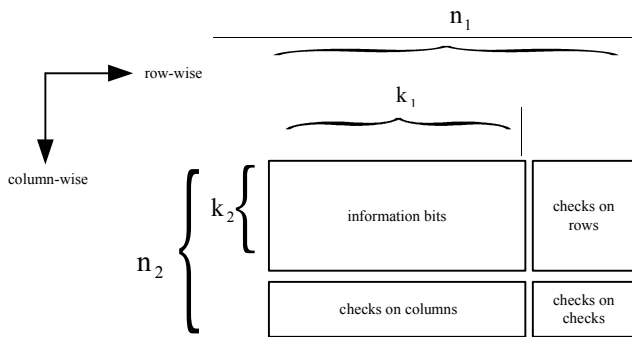

Figure 2. The encoding block of two-dimensional TPCs

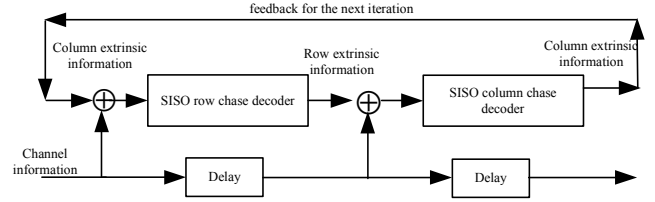

Figure 3. The serial iterative decoder of two-dimensional TPC

The decoding algorithm is based on soft-decision decoding of the constituent codes and high error-correcting performance is achieved by decoding row-wise and column-wise of TPC array repeatedly. As shown in Figure 3, a full-iteration of a TPC decoder performs row and column decoding in a serial fashion. The whole product codeword needs to be decoded row-wise or column-wise for  $N$  times before the next half-iteration can begin, where  $N$  equals the column number and the row number of the product code array.

#### C. Performance of TPCs applied in this paper

Let us consider a system employing three kinds of TPCs and BPSK signaling on an additive white Gaussian noise (AWGN) channel. TPCs structure are  $(16,11,4)^2$ ,  $(32,26,4)^2$ ,  $(64,57,4)^2$ . Figure 4 shows performance of TPCs applied in this paper. The solid vertical lines indicate BER of 0 behind this  $E_s/N_0$  point.

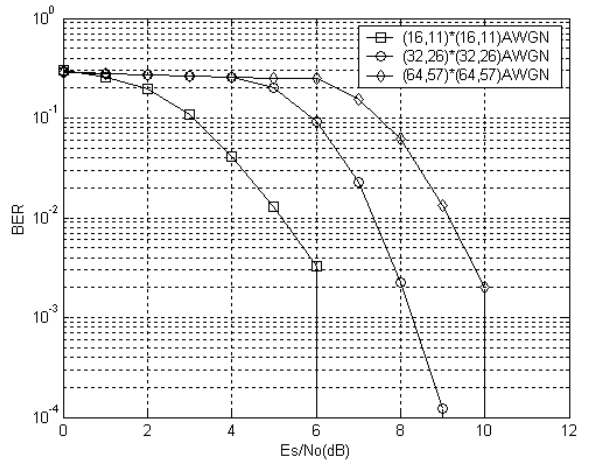

Figure 4. BER versus  $E_s/N_0$  of TPCs on an AWGN channel using BPSK

#### D. Bound on performance of two-dimensional TPCs

The maximum likelihood asymptote (MLA) for a two-dimensional TPCs can be written as<sup>[19]</sup>

$$P_{MLA} = \frac{\delta_1 \delta_2}{n_1 n_2} A_{\delta_1}(c^1) A_{\delta_2}(c^2) Q \left( \sqrt{\frac{2E_b}{N_0} R_1 R_2 \delta_1 \delta_2} \right) \quad (2)$$

where  $E_b$  is the information bit energy,  $R_1$  and  $R_2$  are code rate of  $c^1 = (n_1, k_1, \delta_1)$  and  $c^2 = (n_2, k_2, \delta_2)$ , respectively.

This asymptote is obtained by considering only those code words that have minimum Hamming weight. Using the weight

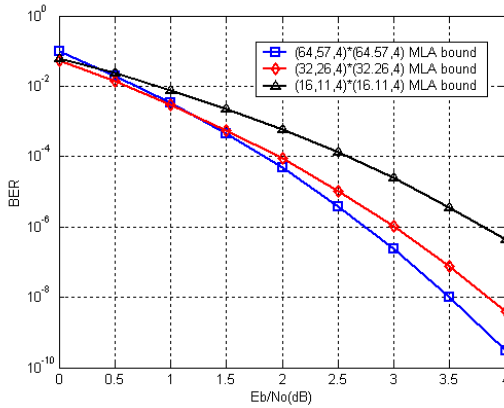

Figure 5. Maximum likelihood asymptote for  $(16,11,4)^2$ ,  $(32,26,4)^2$  and  $(64,57,4)^2$  TPCs

enumerator for extended Hamming code<sup>[20]</sup>, we can show that for an extended  $(64,57,4)$ ,  $(32,26,4)$ ,  $(16,11,4)$  Hamming codes,  $A_4(64,57,4)=10416$ ,  $A_4(32,26,4)=1240$ , and  $A_4(16,11,4)=140$ . Here, the row and column component codes of the TPC are the same. Therefore, we get the MLA for two-dimensional TPCs as described in Figure 5.

#### IV. NUMERICAL SIMULATION

In terms of the proposed scheme in this paper, Each path is modeled as IMT-2000 channels, which include pedestrian a, pedestrian b, vehicle a, vehicle b. Alamouti STBC is employed. The channel estimator is assumed to be ideal. The simulation parameters are shown in Table 1. The Simulations were performed on a Signal Processing Worksystem (SPW) software. The simulation results are shown in Figure 6-9. Signal to noise ratio is defined as  $E_s/N_0=2E_p/N_0$ , where,  $E_p$  denotes signal power per transmit antenna,  $N_0$  denotes noise power.

TABLE I. SIMULATION PARAMETERS

Parameters	Specification
FFT sizes	1024
TPCs Structure	$(16,11,4)^2$ , $(32,26,4)^2$ , $(64,57,4)^2$
Cyclic prefix interval	128
Guard interval	512
Carrier Frequency( $f_c$ )	2GHz
Sampling Frequency	10Mz
The signal power per transmit antenna	$P_s=1$
Channel Model	IMT2000 vehicle a(100km/h) , IMT2000vehicle b(100km/h) IMT2000 pedestrian a(5km/h) , IMT2000 pedestrian b(5km/h)
Block interleaver size	256,1024,4096
Iterative number of TPCs	16
Default Doppler Frequency	$(\text{speed} * f_c) / (2.997 \times 10^8 \times 3.6)$
Number of antenna	2 Transmit antennas and 2 receive antennas

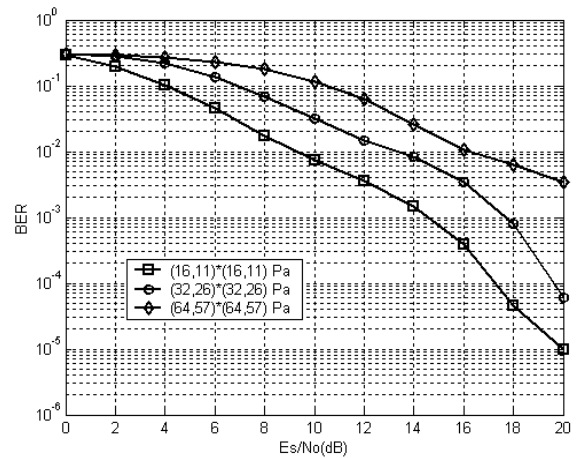

Figure 6. Performance of TPC-STBC coded MIMO-OFDM system over IMT2000-Pa

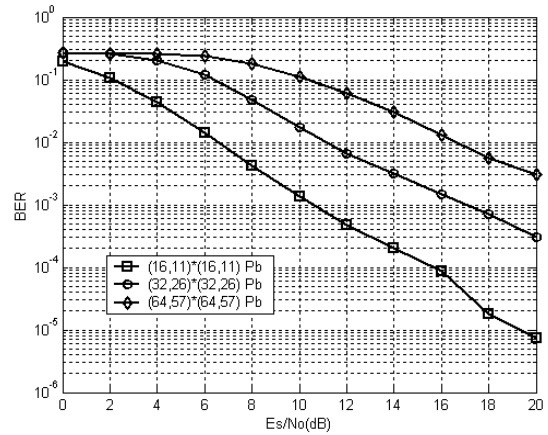

Figure 7. Performance of TPC-STBC coded MIMO-OFDM system over IMT2000-Pb

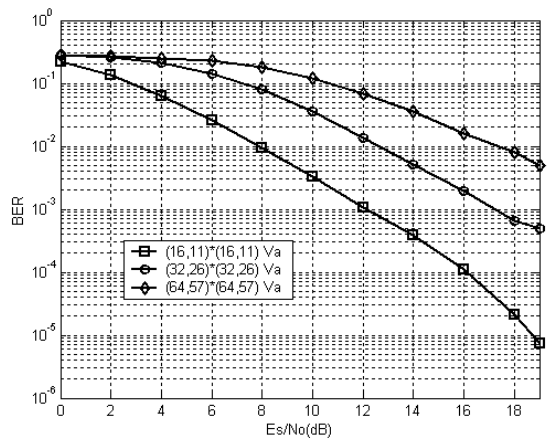

Figure 8. Performance of TPC-STBC coded MIMO-OFDM system over IMT2000-Va

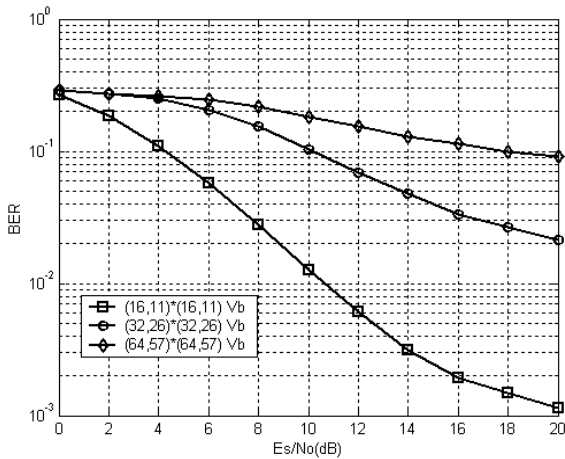

Figure 9. Performance of TPC-STBC coded MIMO-OFDM system over IMT2000-Vb

## V. CONCLUSIONS

In this paper we presented a STBC coded MIMO-OFDM system based turbo product codes (TPCs). This system has been tested on several TPCs based on extended Hamming codes. Simulations indicate that:

- 1) In the same channel, system performance for low code rate TPCs is better than that for high code rate TPCs. There are an identical variety trend for each channel, for example, the BER curve of  $(16,11,4)^2$  TPC is under that of  $(32,26,4)^2$  TPC.
- 2) Using the identical TPC, system performance for IMT-2000 pedestrian A (Pa) channel is best as well as that for IMT-2000 vehicle B (Vb) channel is worst. The result conforms to the channel properties set by ETSI to test UMTS (Universal Mobile Telecommunication System) as third generation standardization.
- 3) Using  $(16,11,4)^2$  TPC over pedestrian A (Pa) channel, pedestrian B (Pb) channel and vehicle A (Va) channel, there are nearly the same performance: BER is about  $10^{-5}$  at SNR of 18 dB. Similarly, using  $(32,26,4)^2$  TPC and  $(64,57,4)^2$  TPC over pedestrian A channel, pedestrian B channel as well as vehicle A channel, there are nearly the same performance: BER is  $10^{-4}$  and  $10^{-3}$  at SNR of 18 dB, respectively.
- 4) The proposed system performance improvement over IMT-2000 vehicle B (Vb) channel needs to be further studied.

## REFERENCES

- [1] Richard D J van Nee, R. Prasad, *OFDM for wireless multimedia communications*, Artech House Publishers, 2000.
- [2] G.L. Stube, J.R. Barr, S.W. McLaughlin, et al., "Broadband MIMO-OFDM wireless communications," *Proceedings of the IEEE*, vol.92, no.2, pp.271-294, Feb.2004
- [3] S.M. Alamouti, "A simple Transmit Diversity Technique for wireless communications," *IEEE Journal of Selected Areas in Communication*, 1998, vol.16, pp.1451-1458, Oct.1998.
- [4] V. Tarokh, H. Jafarkhani, A.R. Calderbank, "Space-time block codes from orthogonal designs," *IEEE Trans. Inform. Theory*, vol.45, pp.1456-1467, July, 1999

- [5] V. Tarokh, N. Seshadri, A.R. Calderbank, "Space-time codes for high data rate wireless communication: performance criterion and code construction," *IEEE Transaction on Information Theory*, vol.44, no.2, pp.744-765, Mar.1998.
- [6] P. W. Wolniansky, G.J. Foschini, G.D. Golden, and R.A. Valenzuela, "V-Blast: An architecture for realizing very high data rates over the rich-scattering channel," in *Proc. Int. Symp. Signals, Systems and Electronics (ISSE 1998)*, pp.295-300.
- [7] J. Ha, A.N. Mody, J.H. Sung, J. Barry, S. McLaughlin, and G. L. Stuber, "LDPC coded OFDM with Alamouti/SVD diversity technique," *J. Wireless Pers. Commun.*, vol.23, no.1, pp.183-194, Oct.2002
- [8] I. Reed, G. Solomon, "Polynomial codes over certain finite fields," *J. Soc. Ind. Appl. Math.*, vol. 8, pp.300-304, 1960.
- [9] C. Berrou, A. Glavieux, P. Thitimajshima, "Near Shannon limit error-correcting coding and decoding: Turbo codes," *IEEE ICC'93*, pp.1064-1070, 1993.
- [10] R. Pyndiah, "Near optimum decoding of product codes: block turbo codes," *IEEE Transaction on Communications*, vol.46, no.8, pp.1003-1010, 1998.
- [11] D.J.C MacKay, "Good error correcting codes based on very sparse matrices," *IEEE Transaction on Inform. Theory*, vol. 45, no.2, pp.399-431, 1999
- [12] G. Bauch, "Concatenation of space-time block codes and turbo-TCM," *IEEE ICC'99*, vol.2, pp.1202-1206, 1999.
- [13] Y.J. Liu, M.P. Fitz, O.Y. Takeshita, "Full rate space-time turbo codes," *IEEE J. Selected Areas in Commun.*, vol.19, no.5, pp.969-980, 2001.
- [14] D.Z. Cui, A.M. Haimovich, "Performance of parallel concatenated space-time codes," *IEEE Communications Letters*, vol.5, no.6, pp.236-238, 2001
- [15] M. Sellathurai, S. Haykin, "Turbo-BLAST for high-speed wireless communications," *IEEE WCNC'2000, Chicago*, vol.1, pp.23-28, 2000
- [16] Y.G. Du, K.T. Chan, "Enhanced space-time block coded systems by concatenating turbo product codes," *IEEE Communications Letters*, vol.8, no.6, pp.388-390, 2004.
- [17] G.X. Zhu, Y.J. He, G. Liu, et al, "Concatenation of space-time block codes and turbo product codes over Rayleigh flat fading Channels," *IEEE VTC2005' Spring, Stockholm, Sweden*, 2005.
- [18] Y.J. He, G.X. Zhu, Y. Z. Liu, et al, "Turbo product codes and their application in the 4th generation mobile communication system," *Proceedings of SPIE*, vol.5284, pp.210-218, 2003.
- [19] M. Ferrari, S. Bellini, "Importance sampling simulation of turbo product codes," *IEEE ICC*, vol.9, pp.2773-2777, 2001.
- [20] X.M. Wang, G.Z. Xiao, "Error-correction codes-principles and methods," <http://www.xduph.com>.